

A T E L I E R



OLDLINE

LEGNO DA VIVERE

SAPORE ITALIANO - *italian flavor*

RA-

DHA

**INDICE - Contents**

**3**  
L'AZIENDA  
*Our Company*

**4**  
LA NOSTRA FILOSOFIA  
*Our philosophy*

**4**  
100% MADE IN ITALY  
*100% Made in Italy*

**5**  
L'ARTIGIANALITÀ  
*Craftsmanship*

**5**  
LA SOSTENIBILITÀ  
*Sustainability*





## L'AZIENDA *our company*



Old Line è un'azienda che affonda le sue radici nella tradizione ebanistica veneta. Nata 40 anni fa da artigiani accomunati dall'amore per la lavorazione del legno, oggi è un'industria strutturata e punto di riferimento nel mondo della cucina tradizionale. Con alle spalle un importante bagaglio di esperienza nel settore, oggi la seconda generazione continua ad immettere sul mercato prodotti dal design classico, contestualizzati in una modernità compositiva per l'arredo di spazi esclusivi. L'utilizzo di materiali pregiati, la cura dei dettagli e di soluzioni tecniche innovative, sono la chiave per la realizzazione di cucine accoglienti, ospitali, funzionali e di raffinata eleganza.

*Old Line's roots are deeply embedded in the cabinet-making tradition of the Veneto region in Italy. Established 40 years ago by artisans who shared a love for timber, ours is now a well-organised company that others in the world of traditional kitchens look up to. Thanks to a heritage of great experience in the sector, the second generation at the helm of the company is still making classic furniture for the market, now contextualised in modern layouts to furnish exclusive spaces. Prized materials, care to detail and innovative technical solutions are the keys to building inviting, cosy, functional and exquisitely elegant kitchens.*





## LA NOSTRA FILOSOFIA *our philosophy*

Recupero e valorizzazione della tradizione.

Questi sono i cardini attorno ai quali ruota la nostra filosofia aziendale. Old Line, infatti, proprio perché nata come piccola realtà artigianale, non ha mai scordato le proprie origini. A quest'ultima continua infatti ad attingere, in un continuo processo innovativo dove la tradizione si sposa con le più moderne tecniche produttive.

Attraverso la valorizzazione del know-how tramandato di padre in figlio, l'azienda è oggi espressione di un'imprenditorialità sostenuta da una genuina passione per il legno e per il design.

*To bring back and enhance tradition.*

*This is the cornerstone of our company philosophy.*

*In fact, since we started as a small, woodworking business, we have never forgotten our origins and we keep drawing from them, in an ongoing process of innovation in which tradition is paired with the most modern production technologies. By making the most of*

*the know-how handed down from father to son, today our company's business skills are backed up by an authentic passion for wood and design.*



## 100% MADE IN ITALY *100% made in italy*

Per Old Line il Made in Italy è un'imprescindibile caratteristica dei propri prodotti. Ogni componente viene infatti lavorato all'interno dell'azienda, dal più semplice al più complesso.

Solo così è possibile garantire l'intera filiera produttiva, con un costante e capillare controllo della qualità dei materiali e delle finiture, per ottenere mobili di eccellenza caratterizzati da un inconfondibile stile italiano.

*The furniture produced by us at Old Line is entirely Made in Italy: an intrinsic and indispensable feature of all our products. Each part, no matter how simple or complex, is made on our premises. We know no other way to guarantee the entire production chain, by means of thorough, ongoing quality controls carried out on materials and finishes to obtain top-quality furniture marked by the unmistakable Italian style.*

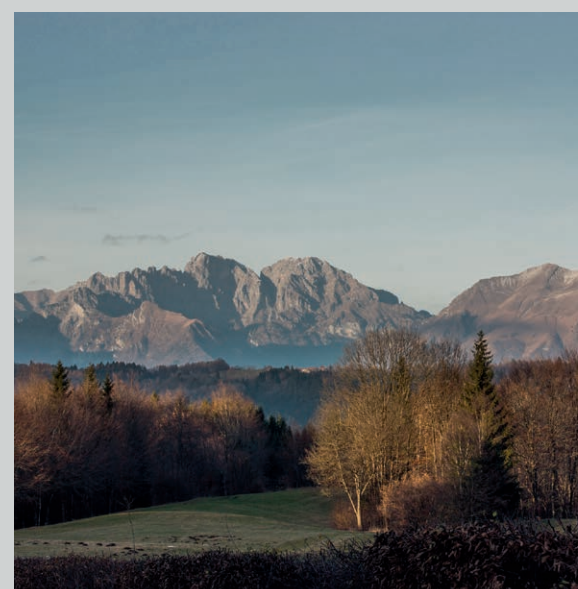

## L'ARTIGIANALITÀ *craftsmanship*

Artigianalità, ovvero saper costruire con amore, come un tempo. Per Old Line questo aspetto fa parte del dna aziendale perché le nostre origini sono proprio quelle di artigiani del legno.

Scegliamo con cura i materiali, selezionandoli e testandoli, consapevoli che la bontà della materia prima è fondamentale per l'ottenimento di prodotti di alta qualità. Nelle lavorazioni impieghiamo tutta la nostra competenza, curando ogni dettaglio, forti di una consolidata esperienza ebanistica.

*Craftsmanship means knowing how to make things with love and care, just like they used to be in the past.*

*Since we started out as cabinet makers, this is still an intrinsic part of our makeup. We choose our materials carefully, selecting them and testing them, well aware that excellent raw materials are essential to make a top-quality product. We invest all our skills in crafting our furniture, taking care of every detail, backed up by our sound experience as cabinet makers.*



## LA SOSTENIBILITÀ *sustainability*

La salvaguardia dell'ambiente è da sempre un aspetto basilare per Old Line.

I nostri processi produttivi vengono continuamente ottimizzati, controllati ed aggiornati.

L'utilizzo di energia elettrica autoprodotta copre fino al 50% del fabbisogno energetico, prezioso contributo ad un processo virtuoso di effettiva eco-sostenibilità.

*For us at Old Line, environmental awareness is essential. Our production processes are continuously optimised, checked and updated. Up to 50% of our electricity requirements are self-produced: an important contribution to a virtuous process of authentic eco-sustainability.*





LE PROPOSTE - *the proposal*

**8**  
COMPOSIZIONE 1  
*Arrangement 1*

**30**  
COMPOSIZIONE 2  
*Arrangement 2*



 **COMPOSIZIONE 1**  
**ARRANGEMENT 1**

**Anta:** modello Gaia  
**Finitura:** laccato opaco Bianco NCS 0300-N e  
Noce Canaletto mod. Canneté  
**Top** Breccia Capraia Vagli

**Doors:** Gaia model  
**Finish:** Matte lacquer White NCS 0300-N and  
Walnut Canaletto model Canneté  
**Breccia Capraia Vagli Top**











Questa sontuosa cucina incarna l'eleganza e il lusso in ogni suo dettaglio. I frontali bianchi, impreziositi da sofisticate cornici ottenute grazie alle esclusive ante Gaia, creano un suggestivo effetto boiserie che trasforma le superfici in raffinate riquadri di pura bellezza.

This sumptuous kitchen embodies elegance and luxury in every detail. The white fronts, enriched by sophisticated frames achieved through the exclusive Gaia doors, create a captivating boiserie effect that transforms the surfaces into refined panels of pure beauty.









L'isola centrale ha ante Cannelé in  
noce Canaletto e top in marmo Breccia  
Capraia Vagli con scanalatura salvagocce.  
All'interno del top, si nasconde un vano  
saliscendi che funge da divisorio e spazio  
di contenimento quando necessario.

The central island features Cannelé  
doors in Canaletto walnut and a top in  
Breccia Capraia Vagli marble with a drip  
groove. Inside the top, a concealed lift-up  
compartment serves as both a divider and  
storage space when needed.













Le colonne in questa cucina di lusso si integrano perfettamente nell'atmosfera sontuosa dell'ambiente, seguendo con eleganza il motivo delle boiserie. Questa coerenza di design conferisce continuità e raffinatezza alle pareti circostanti, contribuendo in modo significativo alla bellezza generale dell'ambiente.

The columns in this luxury kitchen seamlessly blend into the opulent ambiance of the space, elegantly following the boiserie motif. This design coherence provides continuity and sophistication to the surrounding walls, significantly enhancing the overall beauty of the environment.











Il tavolo in marmo, le sedie confortevoli e la madia con lavorazione Cannelé completano l'ambiente cucina in perfetta sintonia. Una continuità visiva ed estetica che sottolinea l'armonia e l'eleganza di tutto l'insieme.

The marble table, comfortable chairs, and the sideboard with Cannelé detailing harmoniously complete the kitchen space. A visual and aesthetic continuity that underscores the harmony and elegance of the entire ensemble.







**SCHEDA TECNICA**  
**COMPOSIZIONE**  
*Technical data sheet for arrangements*

ANTA  
Door



GAIA

ANTA  
Door



CANNETÉ

**FINITURE UTILIZZATE**  
*Finishes used*

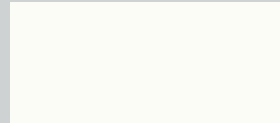

Bianco - Laccato NCS 0300-N  
 White - NCS 0300-N lacquered

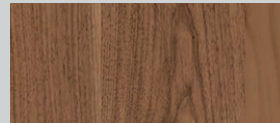

Noce Canaletto  
 Black Walnut



Breccia Capraia Vagli  
 Breccia Capraia Vagli

VISTA IN PIANTA  
*Top view*

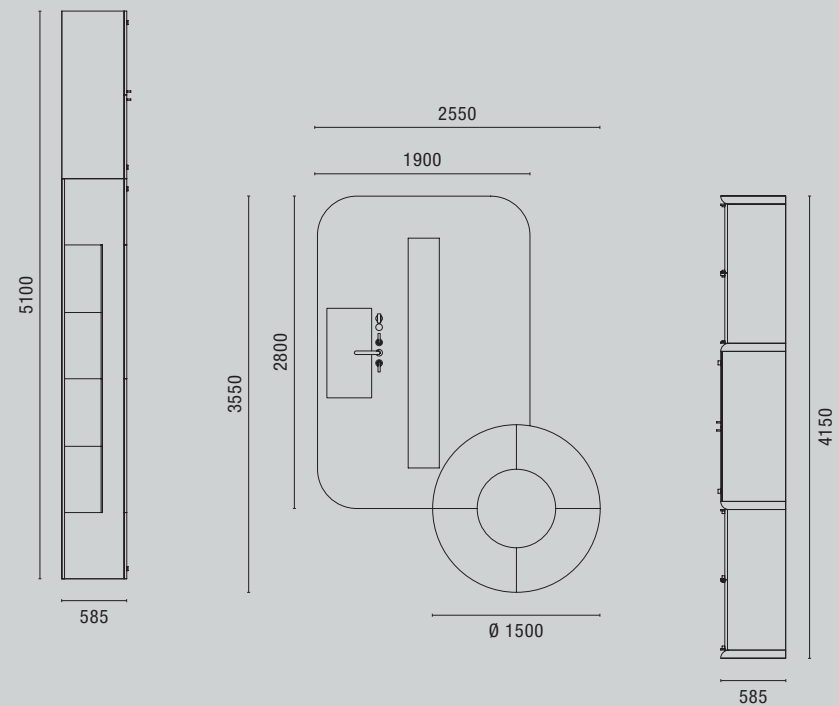
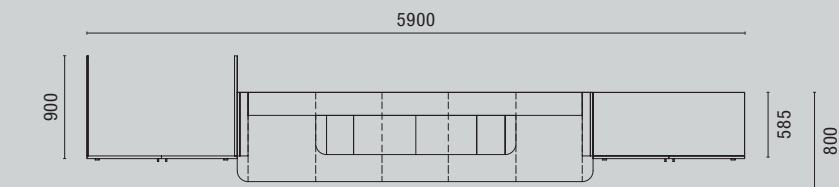

PROSPETTO A-A  
*Front view A-A*

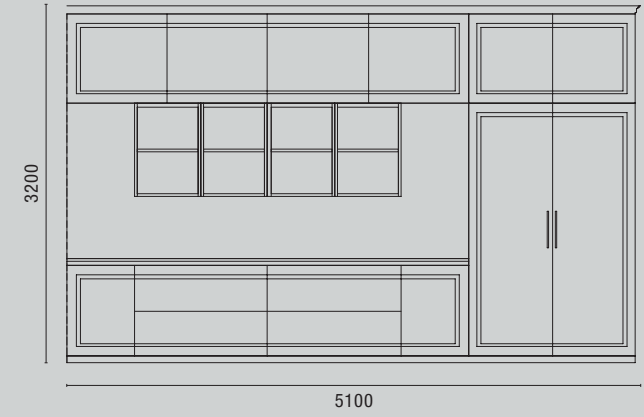

PROSPETTO B-B  
*Front view B-B*

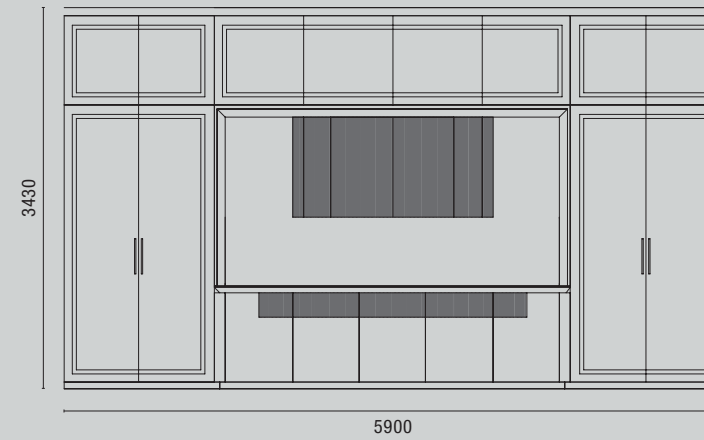

PROSPETTO C-C  
*Front view C-C*

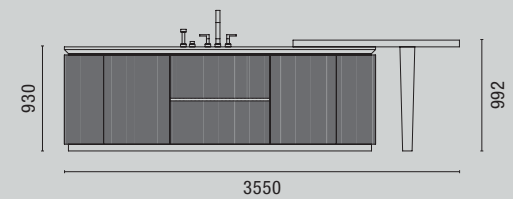

PROSPETTO D-D  
*Front view D-D*

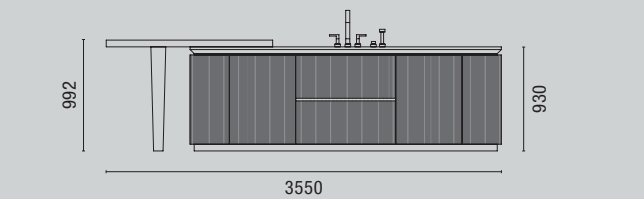

PROSPETTO E-E  
*Front view E-E*

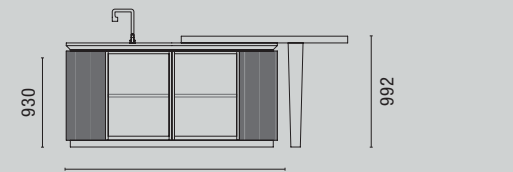

PROSPETTO F-F  
*Front view F-F*

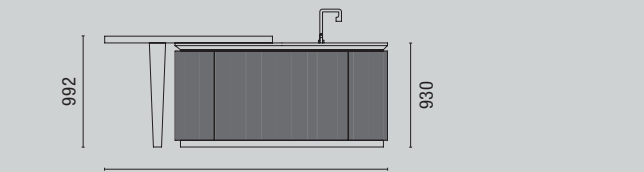

PROSPETTO G-G  
*Front view G-G*





 **COMPOSIZIONE 2**  
**ARRANGEMENT 2**

**Anta:** modello Gaia  
**Finitura:** laccato opaco Perla NCS 1500-N e  
anta Alpha Rovere Naturale  
**Top** Carrara Venato

**Doors:** Gaia model  
**Finish:** Matte lacquer Pearl NCS 1500-N and  
Alpha door in Natural Oak  
**Carrara Venato Top**













Questa variante della cucina in finitura chiara presenta frontali laccati opaco Perla, che conferiscono un'eleganza discreta. Il top in marmo Carrara Venato aggiunge luminosità e sofisticatezza, creando un contrasto delicato. L'isola centrale, con dettagli in rovere naturale, apporta calore e naturalezza all'ambiente.

This variant of the light-finished kitchen features matte Perla lacquered fronts, bestowing a discreet elegance. The Carrara Venato marble top adds brightness and sophistication, creating a delicate contrast. The central island, with natural oak details, brings warmth and naturalness to the environment.









Sia funzionali che decorativi, i vani sottopensile dotati di ante in vetro e profili metallici in finitura champagne, si trasformano in un elemento di grande impatto visivo, rendendo l'ambiente ancora più straordinario.

Both functional and decorative, the under-cabinet compartments with glass doors and champagne-finished metal profiles transform into a visually striking element, making the environment even more extraordinary.





La madia in rovere naturale con il piano in marmo aggiunge uno stile raffinato ed elegante all'ambiente. I frontali anta Alpha liscia, si integrano in modo armonioso con il piano in marmo, creando un accoppiamento visivamente accattivante grazie all'altezza leggermente superiore e allo svasamento rispetto al top. Questo pezzo d'arredo aggiunge prestigio all'ambiente, completando l'insieme con classe e sofisticazione.

The natural oak sideboard with the marble top adds a refined and elegant style to the environment. The smooth fronts of the Alpha door blend harmoniously with the marble top, creating a visually appealing combination due to the slightly elevated height and the tapering compared to the surface. This piece of furniture adds prestige to the space, completing the ensemble with class and sophistication.







**SCHEDA TECNICA  
COMPOSIZIONE**  
*Technical data sheet for  
arrangements*

ANTA  
Door



GAIA

ANTA  
Door



ALPHA

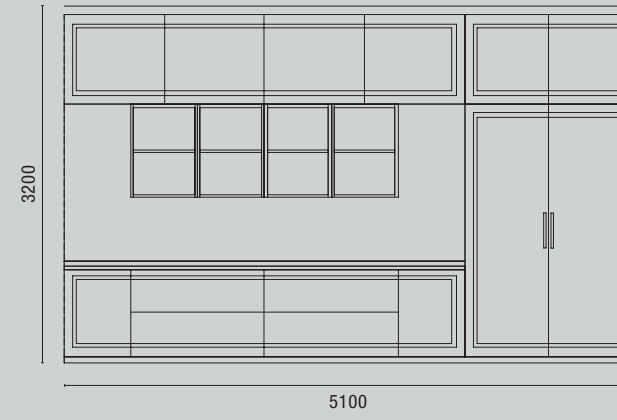

PROSPETTO A-A  
Front view A-A

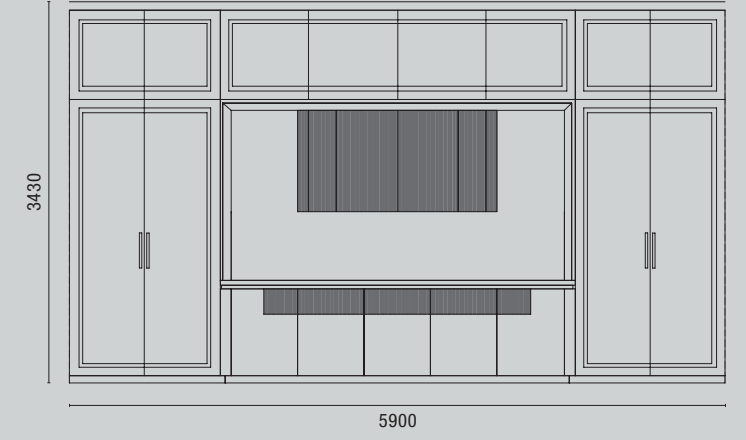

PROSPETTO B-B  
Front view B-B

FINITURE UTILIZZATE  
*Finishes used*



Perla - Laccato NCS 1500-N  
*Perla - NCS 1500-N lacquer*



Rovere Naturale  
*Natural Oak*

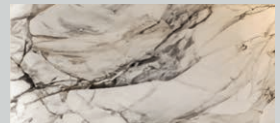

Carrara Venato  
*Carrara Venato*

VISTA IN PIANTA  
*Top view*

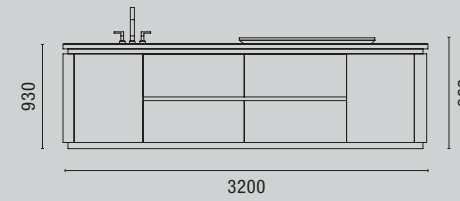
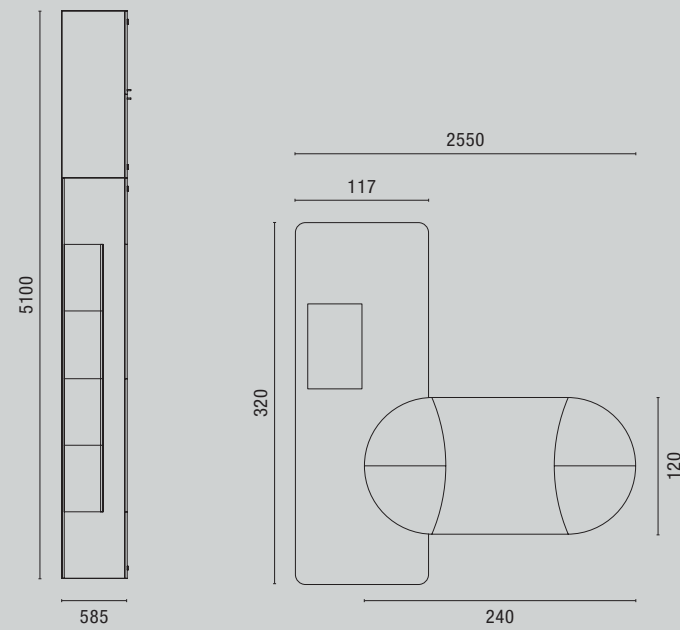
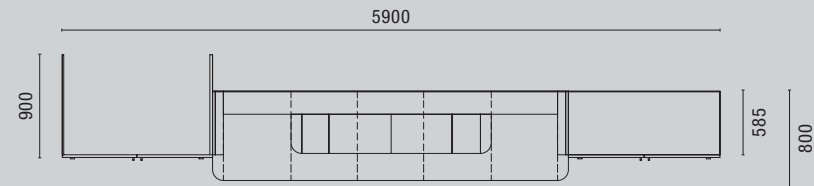

PROSPETTO C-C  
Front view C-C

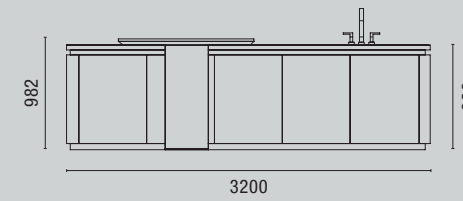

PROSPETTO D-D  
Front view D-D

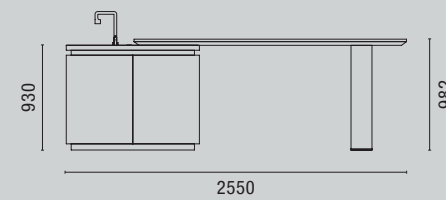

PROSPETTO E-E  
Front view E-E



# ANTA GAIA

GAIA DOOR



# FINITURE

FINISHES



ANTA SPESSORE 20 mm E 36 mm ALLA CORNICE  
*door thickness 20 mm and 36 mm at the frame*

ANTA GAIA  
 LACCATI OLD LINE  
*Gaia door*  
 Old Line lacquers



LACCATI OLD LINE / OLD LINE LACQUERS

CONFIGURAZIONI  
*Configurations*



SX

DX



SX

CASSETTO O ANTA RIBALTA

SX



# ANTA CANNETÉ

CANNETÉ DOOR

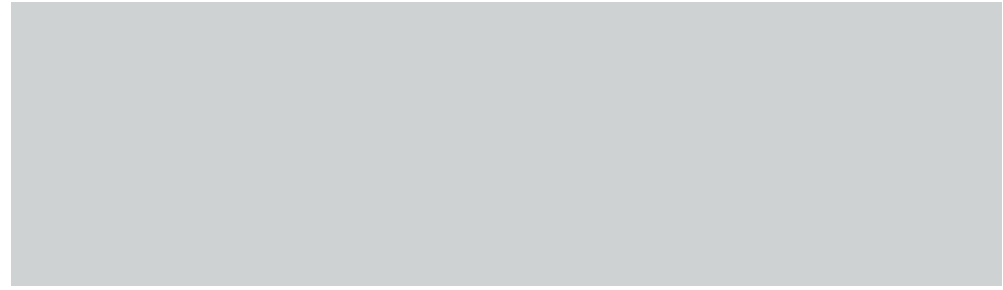

# FINITURE

FINISHES

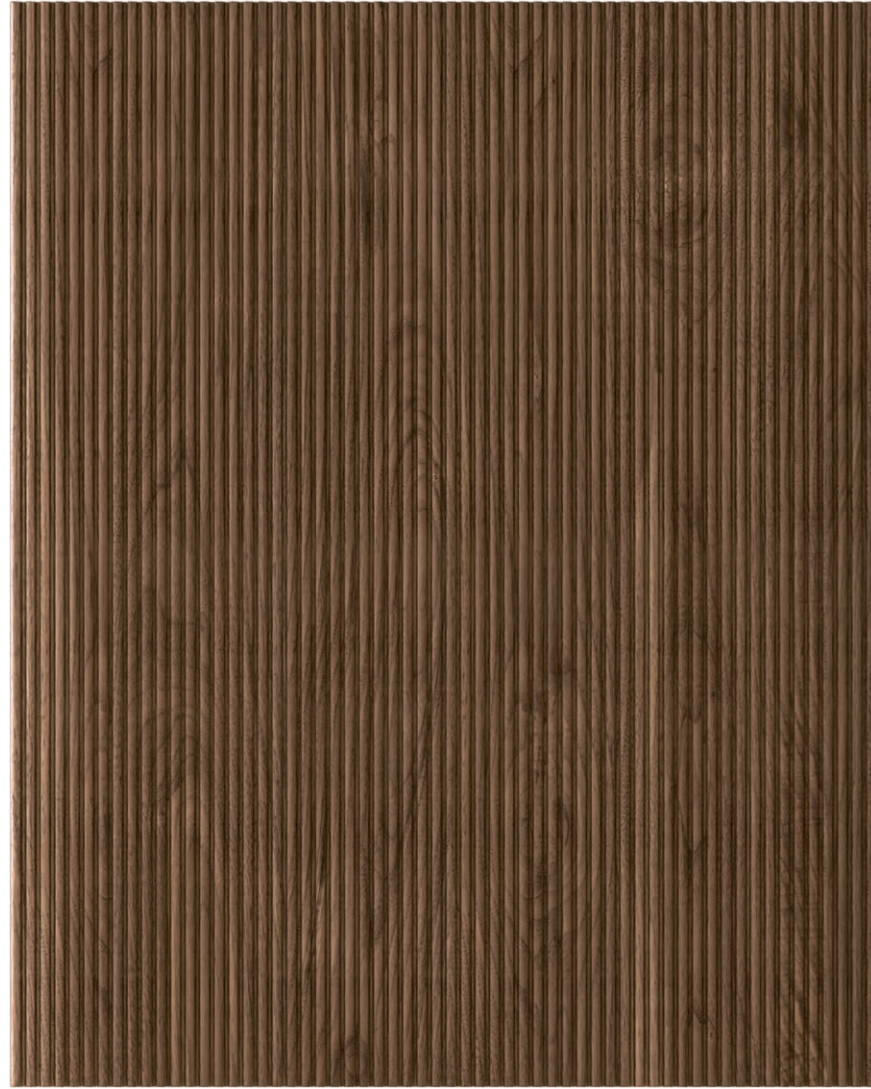
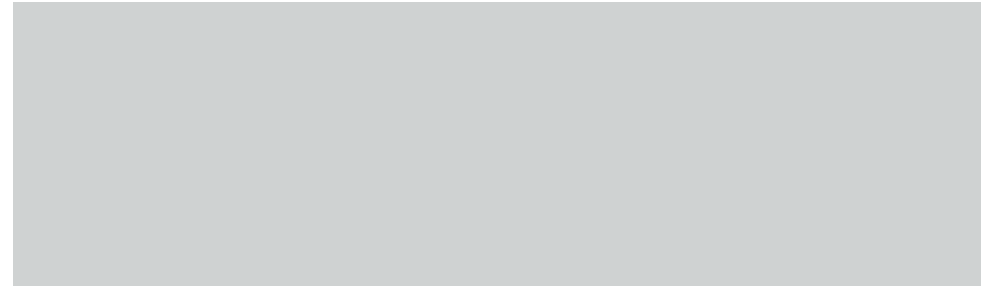

ANTA SPESSORE 25 mm  
*25 mm thick door*

25 mm



ANTA CANNETÉ  
*Canneté door*



NOCE CANALETTO / BLACK WALNUT

ANTA CANNETÉ  
LACCATI OLD LINE  
*Canneté door*  
*Old Line lacquers*



LACCATI OLD LINE / OLD LINE LACQUERS



# ANTA ALPHA

ALPHA DOOR

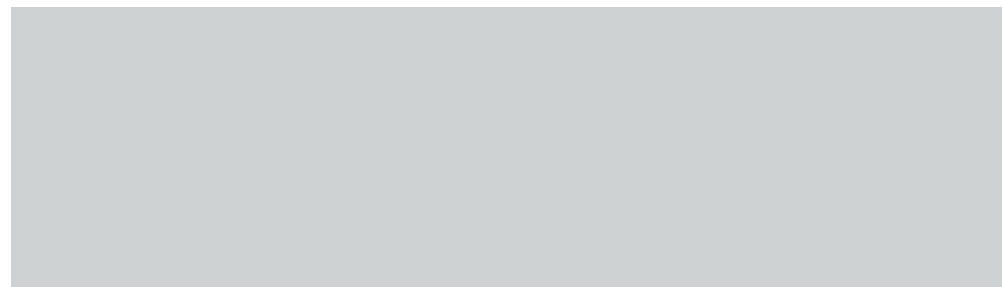

# FINITURE

FINISHES

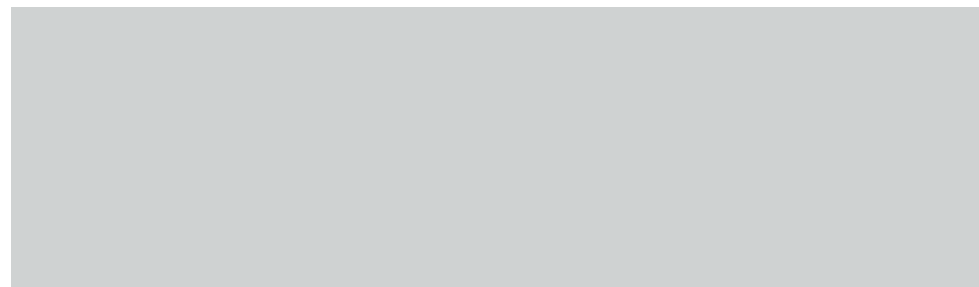

ANTA SPESSORE 20 mm  
*20 mm thick door*

20 mm



ANTA LISCIA  
*Plain door*



ROVERE / OAK

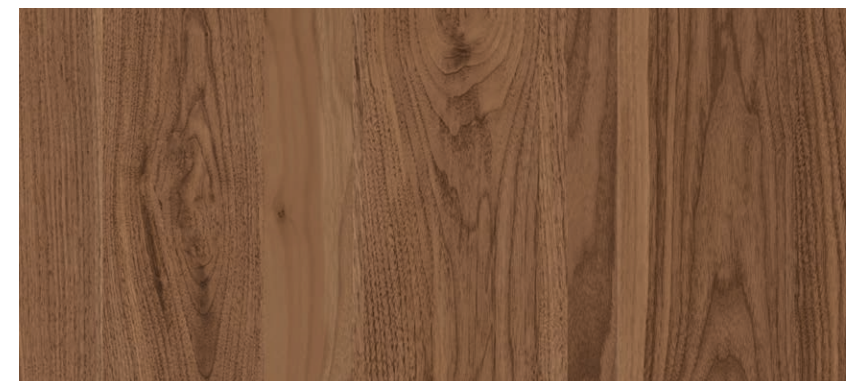

NOCE CANALETTO / BLACK WALNUT

ANTA LISCIA  
LACCATI OLD LINE  
*Plain door Old Line  
lacquered*

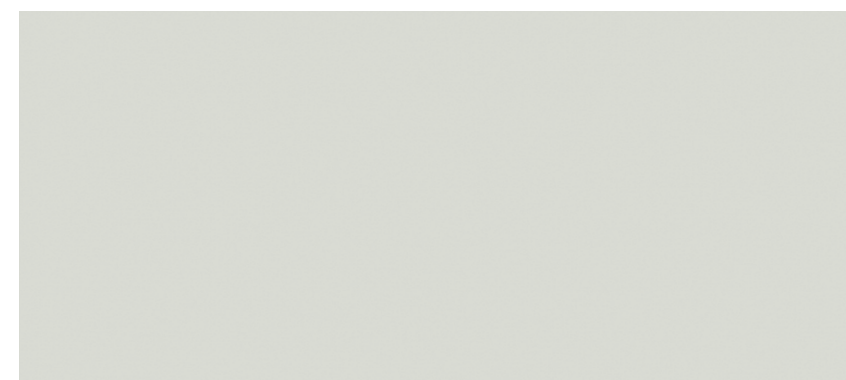

LACCATI OLD LINE / OLD LINE LACQUERS



# LACCATI NCS

LACQUERED NCS

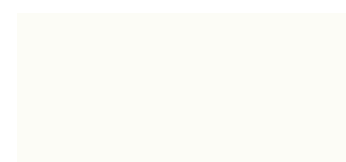

BIANCO - NCS 0300-N

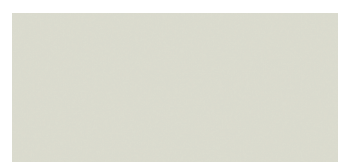

PERLA - NCS 1500-N



RUGIADA - NCS 2502-Y



COLOMBA - NCS 3500-N



SETA - NCS 1502-G50Y

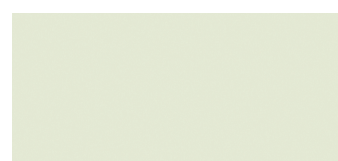

NEBBIA - NCS 1005-G70Y



FUMO - NCS 2005-G60Y



POLVERE - NCS 3005-G20Y

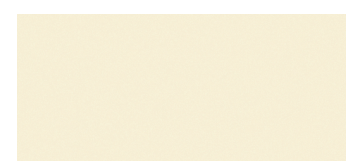

CORDA - NCS 0804-Y30R

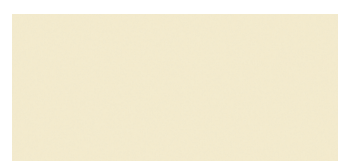

CANAPA - NCS 0907-Y10R



AVORIO - NCS 1505-Y30R



SABBIA - NCS 2030-G90Y



SENAPE - NCS 3005-Y50R



TORTORA - NCS 4005-Y20R



OMBRA - NCS 5005-G80Y



DAINO - NCS 5502-Y



PIOGGIA - NCS 6000-N

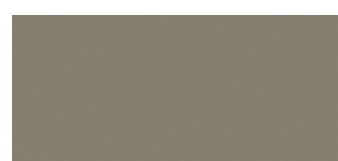

CASTORO - NCS 5005-Y20R



CENERE - NCS 5005-Y50R



CAPPUCCINO - NCS 4010-G90Y



CAFFÈ - NCS 7010-Y70R



VERDE - NCS S6010-B70G



BOSCO - NCS 7010-B30G



PETROLIO - NCS 7010-B10G



NUVOLA - NCS 4020-B10G



PIETRA - NCS 4005-B20G



CIPRIA - NCS S3010Y-50R



TERRA - NCS 6030-Y90R



RUBINO - NCS 2570-R



PIOMBO - NCS 6502-G



CARBONE - NCS 7502-Y



CORTECCIA - NCS 8000-N



GRAFITE - NCS 7502-B



NERO - NCS 9000N



**OLDLINE ARREDAMENTI SRL**

Via Cal Larga, 56

31010 Mareno di Piave

Treviso - Italy

T. +39 0438 492506

F. +39 0438 492549

[oldline@oldline.it](mailto:oldline@oldline.it)

[www.oldline.it](http://www.oldline.it)